



DRAWN BY:

MT

ROOFSCREEN MFG., INC.  
347 CORAL STREET  
SANTA CRUZ, CA 95060

PRINT DATE: 11/10/2016

REV. DATE: 11/10/2016

SCALE:

NTS

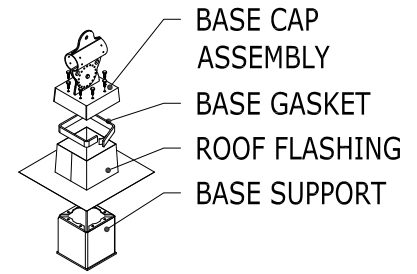

EXPLODED VIEW

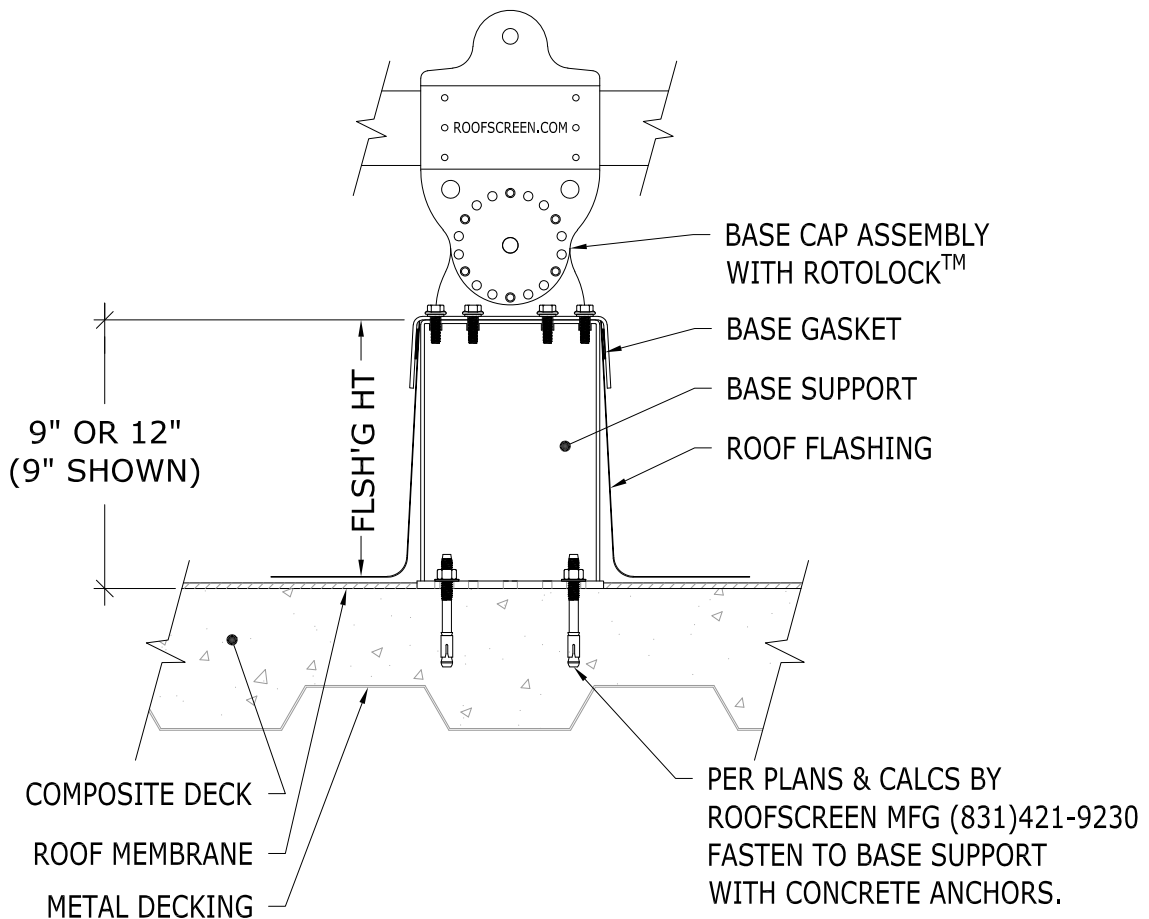

COMPOSITE (STRUCTURAL CONCRETE OVER METAL DECKING)  
CONCRETE ANCHORS - NO INSULATION - NO EXTENSION

ROOFSCREEN MFG., INC.  
 347 CORAL STREET  
 SANTA CRUZ, CA 95060

PRINT DATE: 11/10/2016

REV. DATE: 11/10/2016

SCALE:

NTS

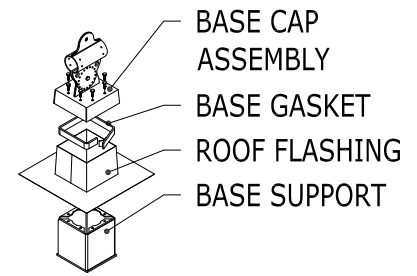

EXPLODED VIEW

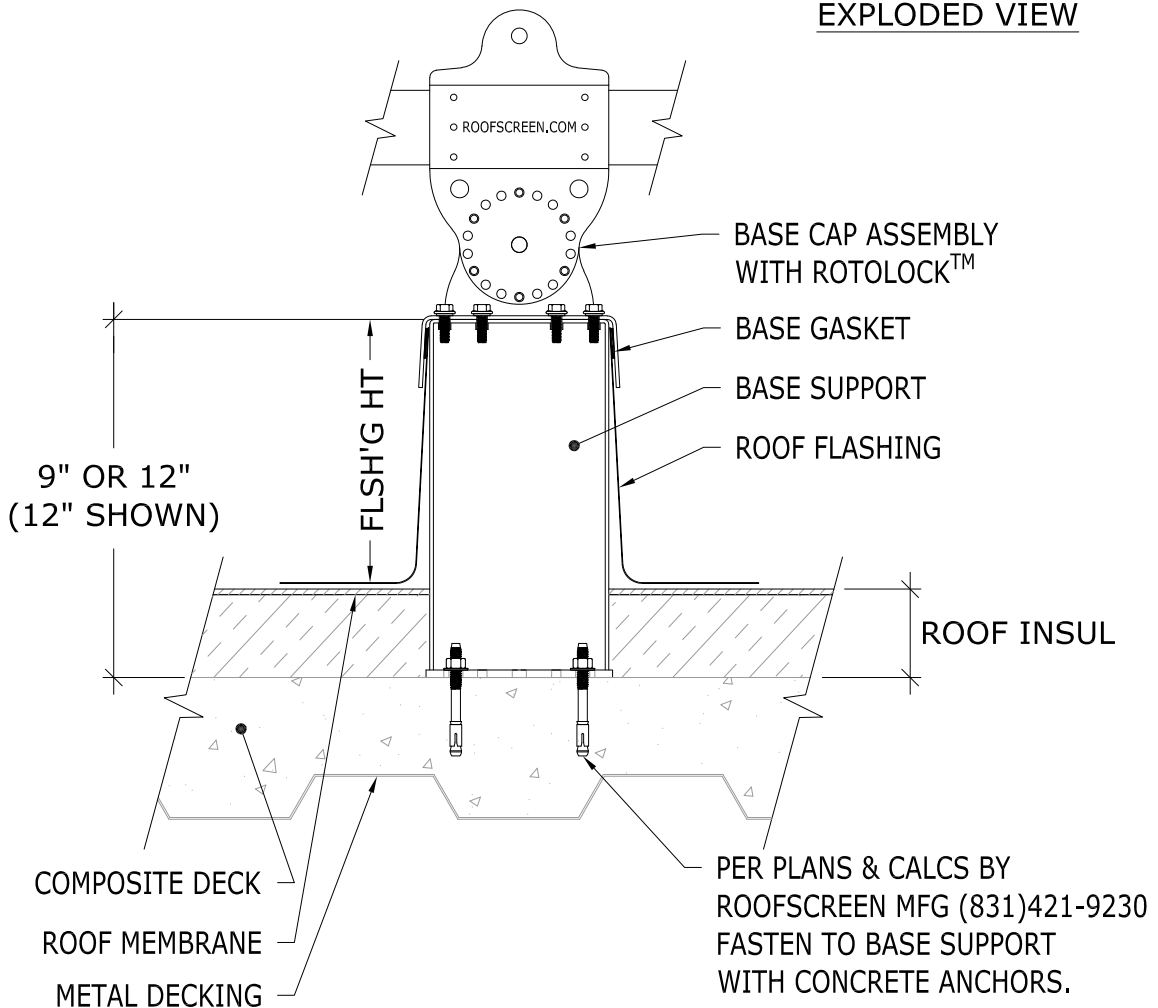

COMPOSITE (STRUCTURAL CONCRETE OVER METAL DECKING)  
 CONCRETE ANCHORS - WITH INSULATION - NO EXTENSION

ROOFSCREEN MFG., INC.  
 347 CORAL STREET  
 SANTA CRUZ, CA 95060

PRINT DATE: 11/10/2016

REV. DATE: 11/10/2016

SCALE:

NTS

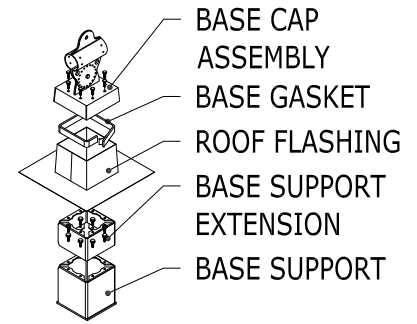

EXPLODED VIEW

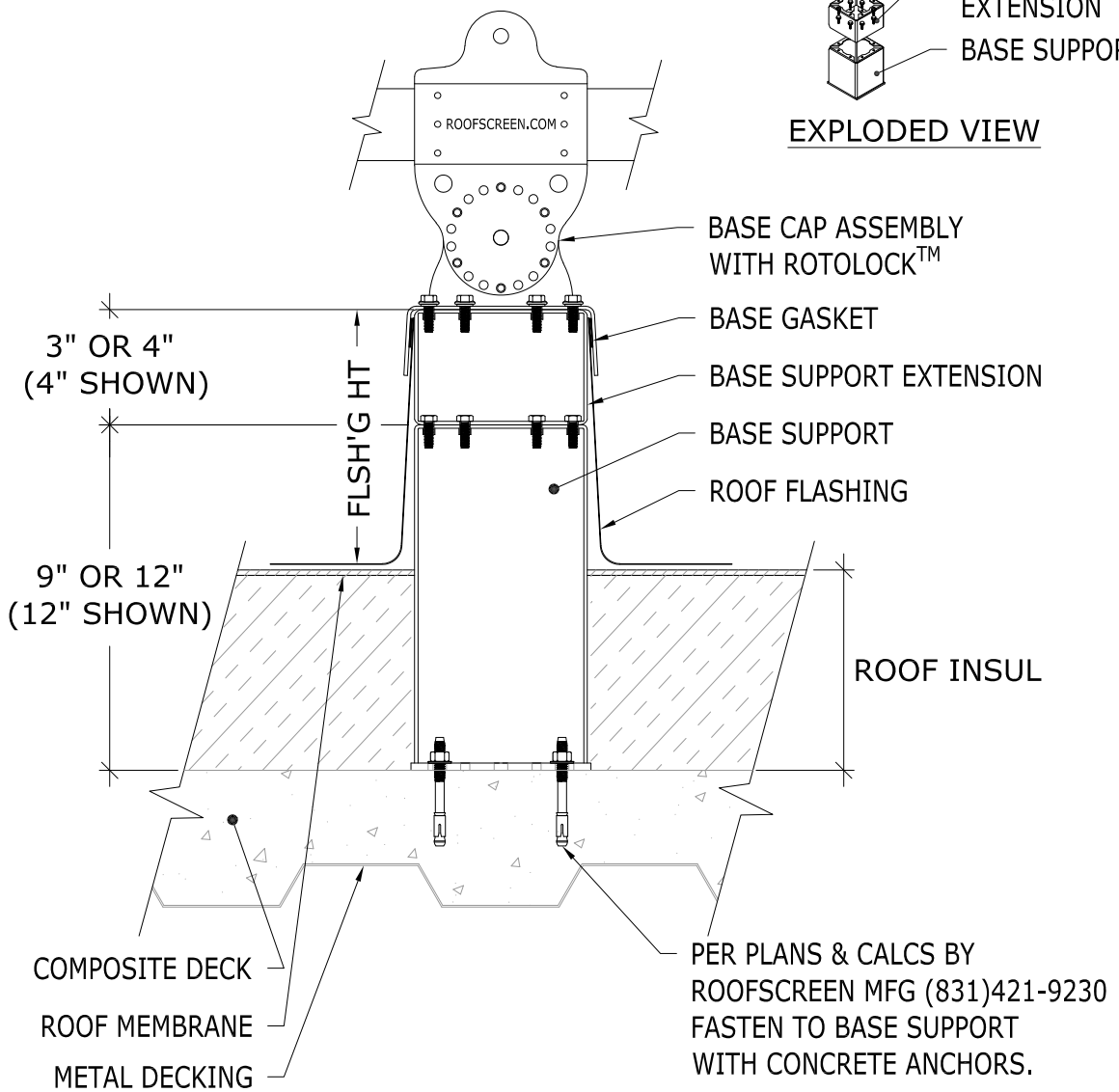

COMPOSITE (STRUCTURAL CONCRETE OVER METAL DECKING)  
 CONCRETE ANCHORS - WITH INSULATION - WITH EXTENSION



DRAWN BY: MT

ROOFSCREEN MFG., INC.  
347 CORAL STREET  
SANTA CRUZ, CA 95060

PRINT DATE: 11/10/2016

REV. DATE: 11/10/2016

SCALE: NTS

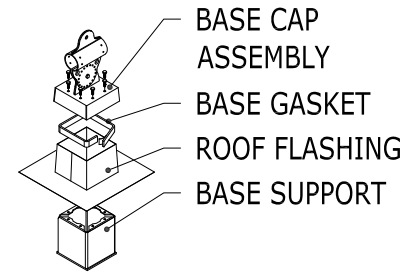

EXPLODED VIEW

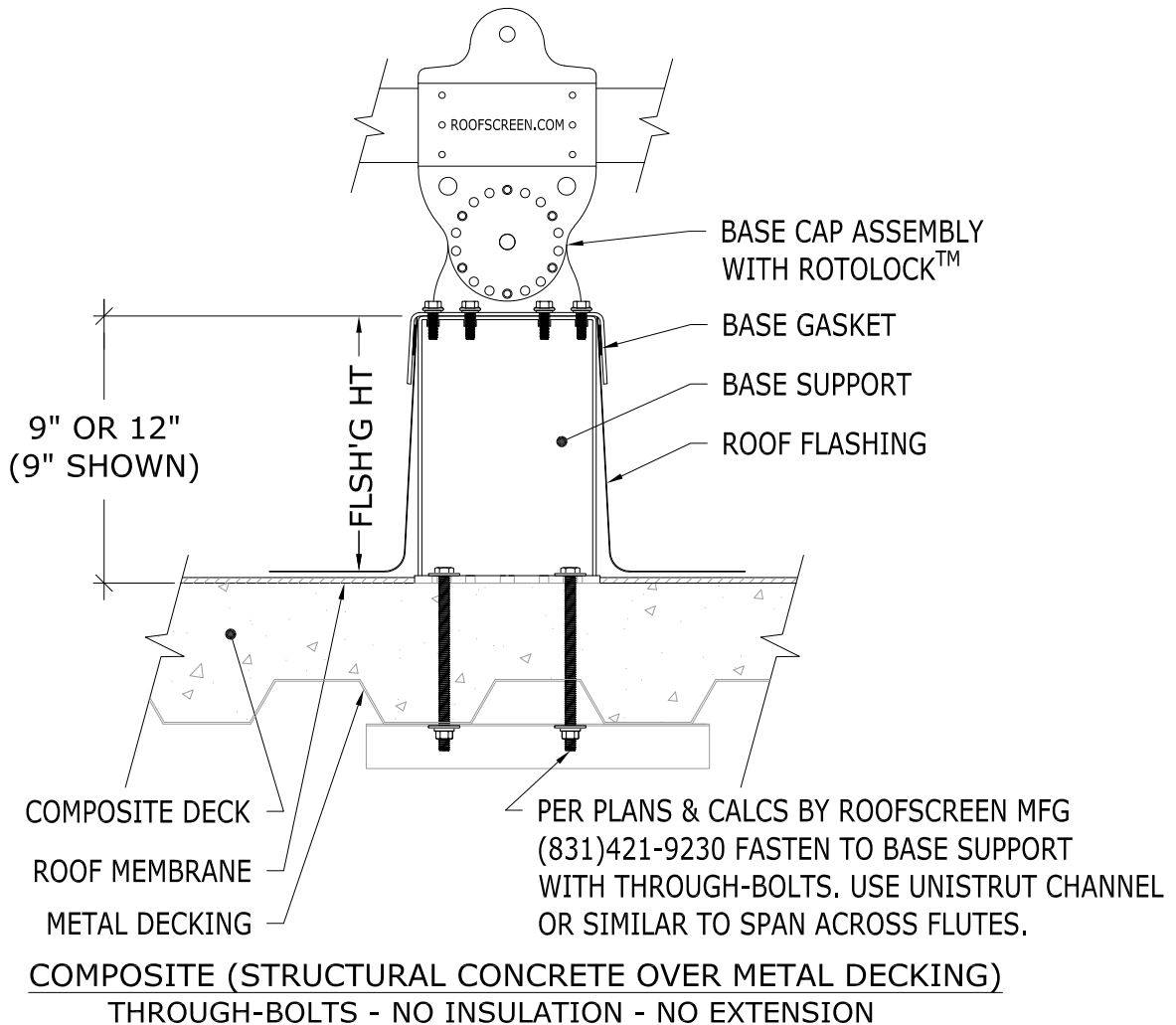

ROOFSCREEN MFG., INC.  
347 CORAL STREET  
SANTA CRUZ, CA 95060

PRINT DATE: 11/10/2016

REV. DATE: 11/10/2016

SCALE:

NTS

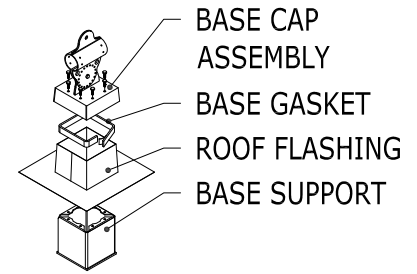

EXPLODED VIEW

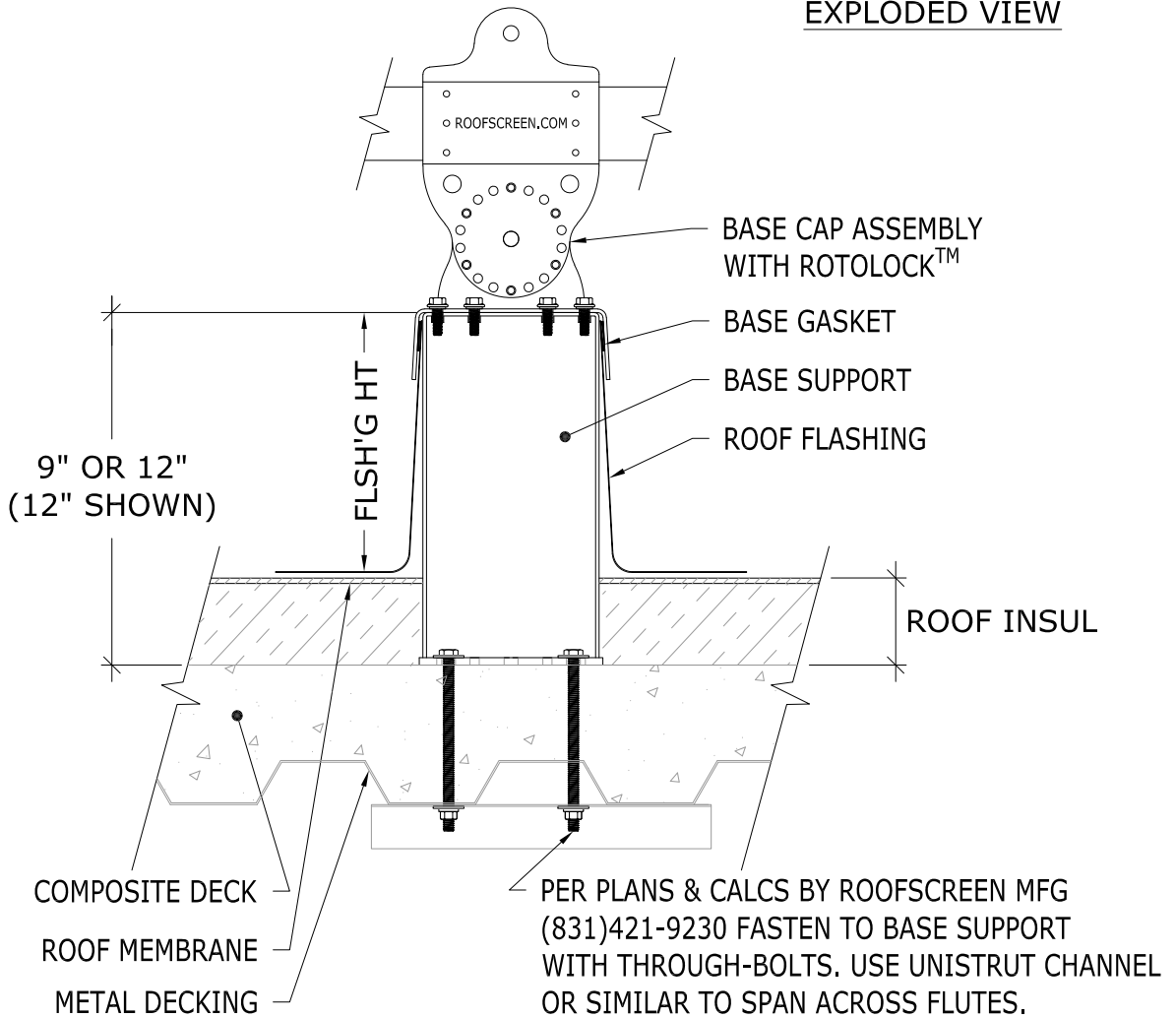

COMPOSITE (STRUCTURAL CONCRETE OVER METAL DECKING)  
THROUGH-BOLTS - WITH INSULATION - NO EXTENSION

ROOFSCREEN MFG., INC.  
 347 CORAL STREET  
 SANTA CRUZ, CA 95060

PRINT DATE: 11/10/2016

REV. DATE: 11/10/2016

SCALE:

NTS

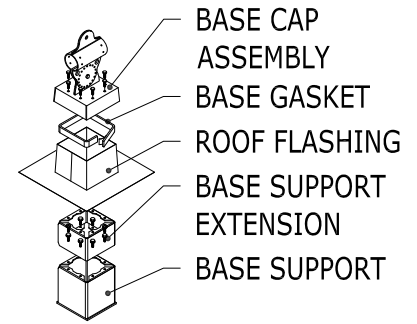

EXPLODED VIEW

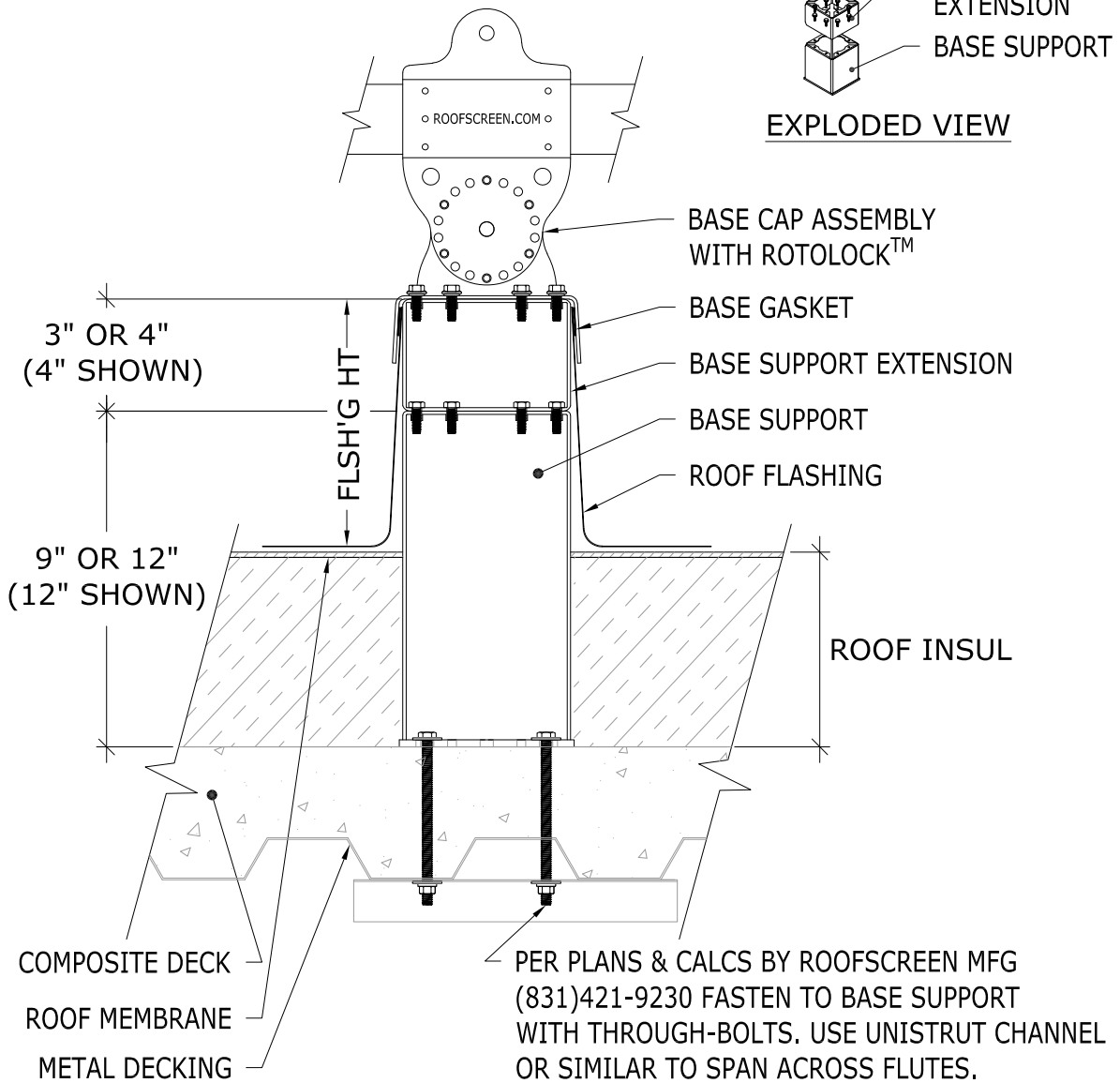

COMPOSITE (STRUCTURAL CONCRETE OVER METAL DECKING)  
 THROUGH-BOLTS - WITH INSULATION - WITH EXTENSION



DRAWN BY:

MT

ROOFSCREEN MFG., INC.  
347 CORAL STREET  
SANTA CRUZ, CA 95060

PRINT DATE: 11/10/2016

REV. DATE: 11/10/2016

SCALE:

NTS

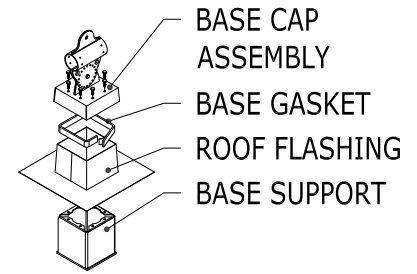

EXPLODED VIEW

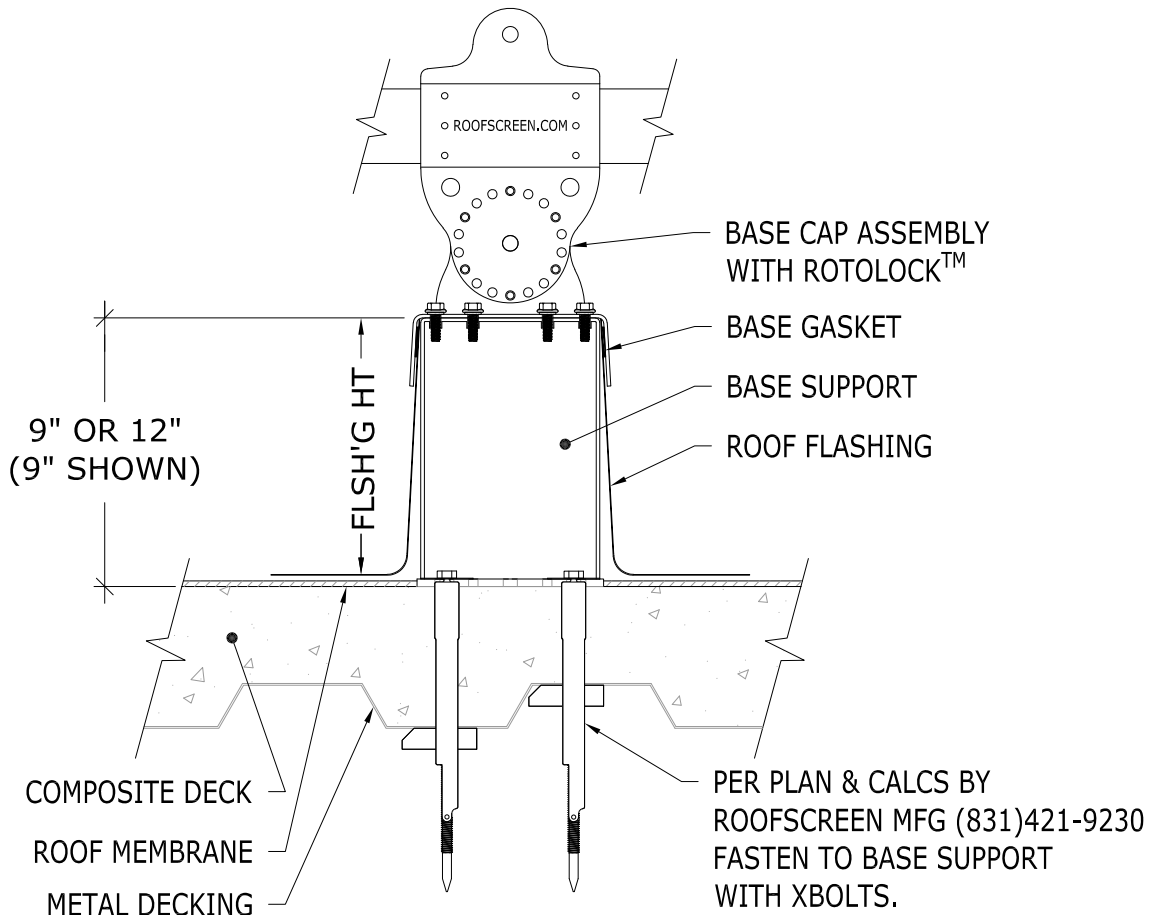

COMPOSITE (STRUCTURAL CONCRETE OVER METAL DECKING)  
XBOLTS - NO INSULATION - NO EXTENSION

ROOFSCREEN MFG., INC.  
347 CORAL STREET  
SANTA CRUZ, CA 95060

PRINT DATE: 11/10/2016

REV. DATE: 11/10/2016

SCALE:

NTS

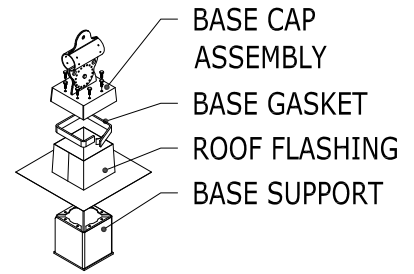

EXPLODED VIEW

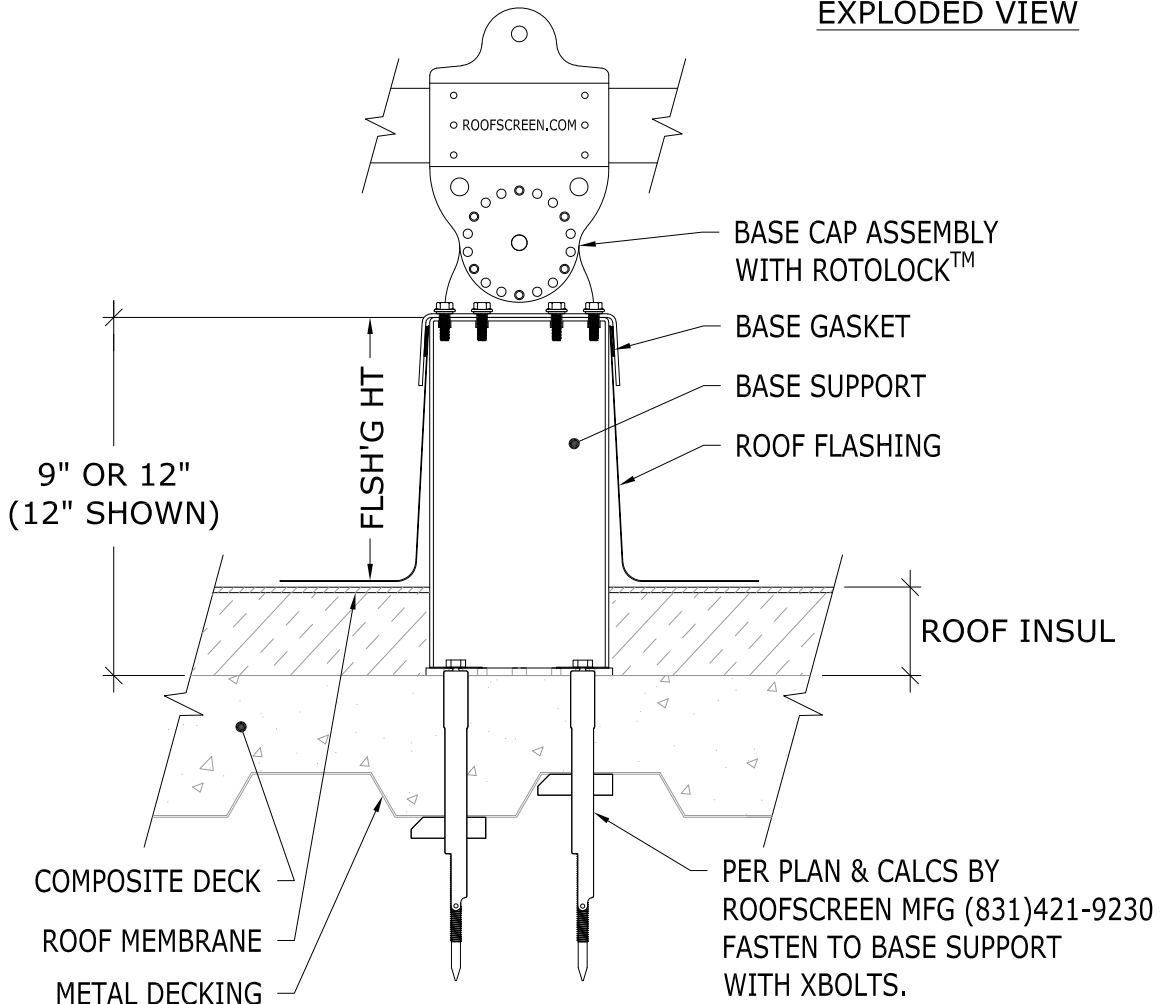

COMPOSITE (STRUCTURAL CONCRETE OVER METAL DECKING)  
X-BOLTS - WITH INSULATION - NO EXTENSION



ROOFSCREEN MFG., INC.  
347 CORAL STREET  
SANTA CRUZ, CA 95060

PRINT DATE: 11/10/2016

REV. DATE: 11/10/2016

SCALE:

NTS

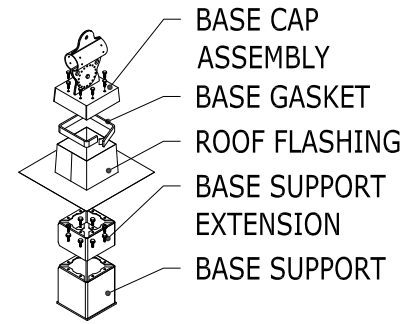

EXPLODED VIEW

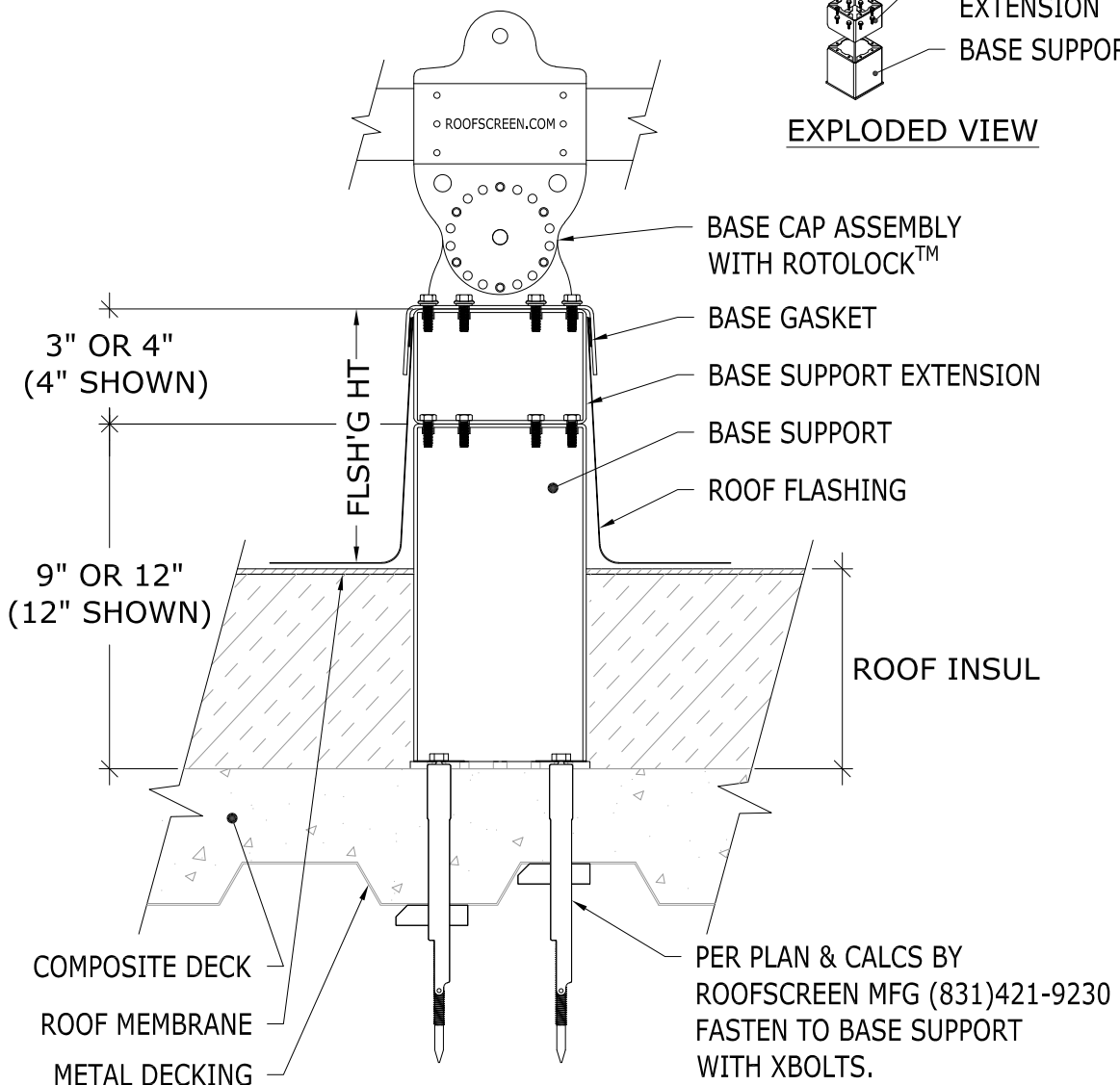

COMPOSITE (STRUCTURAL CONCRETE OVER METAL DECKING)  
XBOLTS - WITH INSULATION - WITH EXTENSION